



ABB i-bus[®] KNX

New Products 2008



Overview of New Products 2008 KNX

- Analogue Input
- Fan Coil Actuator
- IP Router, IP Interface
- Light Controller, Light Sensor
- Room Master
- Telephone Gateway
- Universal Dim Actuator
- Phase Busbar



ABB i-bus® KNX Analogue Input AE/A 2.1





- Analogue Input AE/A 2.1
- SM (Surface Mounting)
- Splash Guard IP 54
- Two Channels
- Only active Sensors need an external Power Supply

- **Connection of standard Sensors e.g.**

- **Voltage** **0 – 1 V**

- 0 – 5 V**

- 0 – 10 V**

- 1 – 10 V**

- **Current** **0 – 20 mA**

- 4 – 20 mA**



- **Connection of standard Sensors e.g.**

- **Resistor**

0 – 1.000 Ohm

PT 100 (-50...+150°C)

PT 1.000 (-50...+150°C)

Selection of KT and KTY

KT and KTY user defined

ABB i-bus® KNX Fan Coil-Actuator FCA/S 1.1M

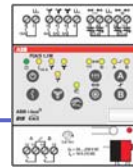



- Fan Coil-Actuator
- FCA/S 1.1M
- 4 MW, MDRC
- Plastic Foil Keypad

	Anzahl
Inputs	
Binary via Contact Scanning	2
Outputs	
Relay 16 A (10 AX)	1
Relay 6 A	3
Electronic 0,5 A	4

■ Plastic Foil Keypad, Manual Operation

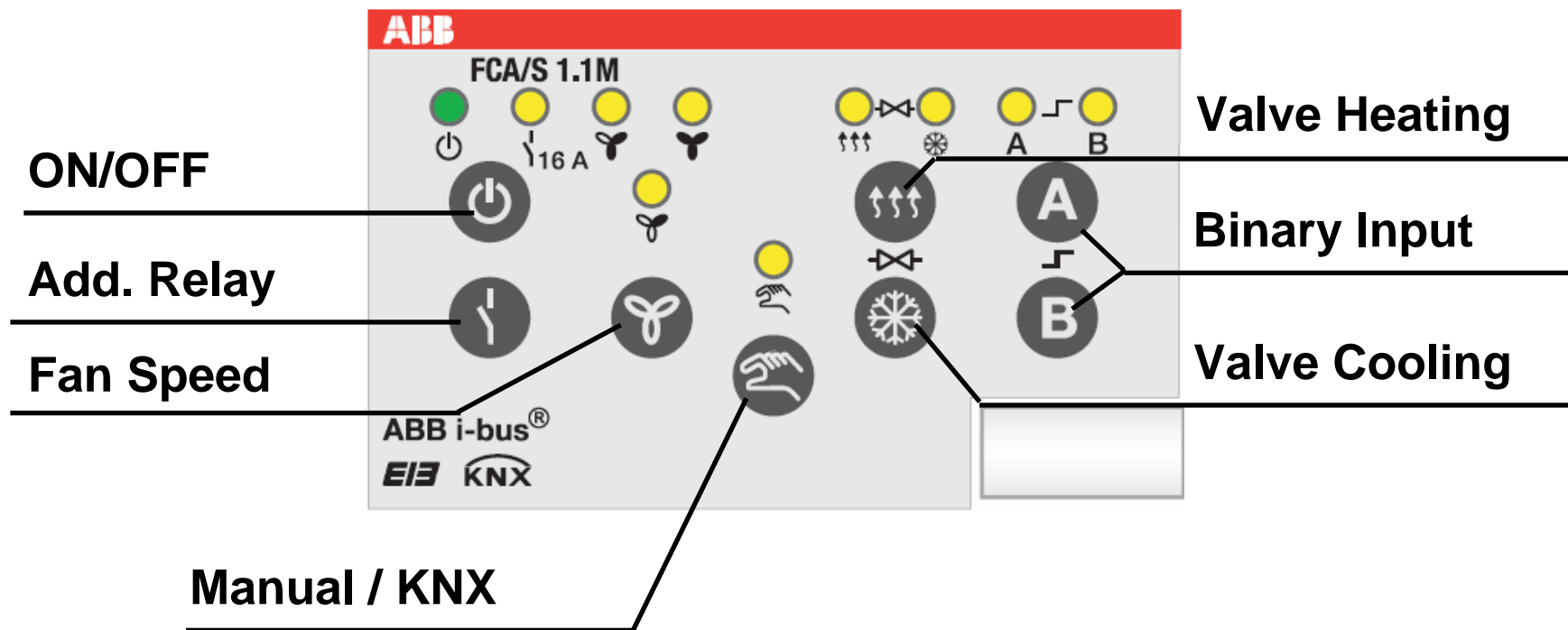

■ Plastic Foil Keypad, Display

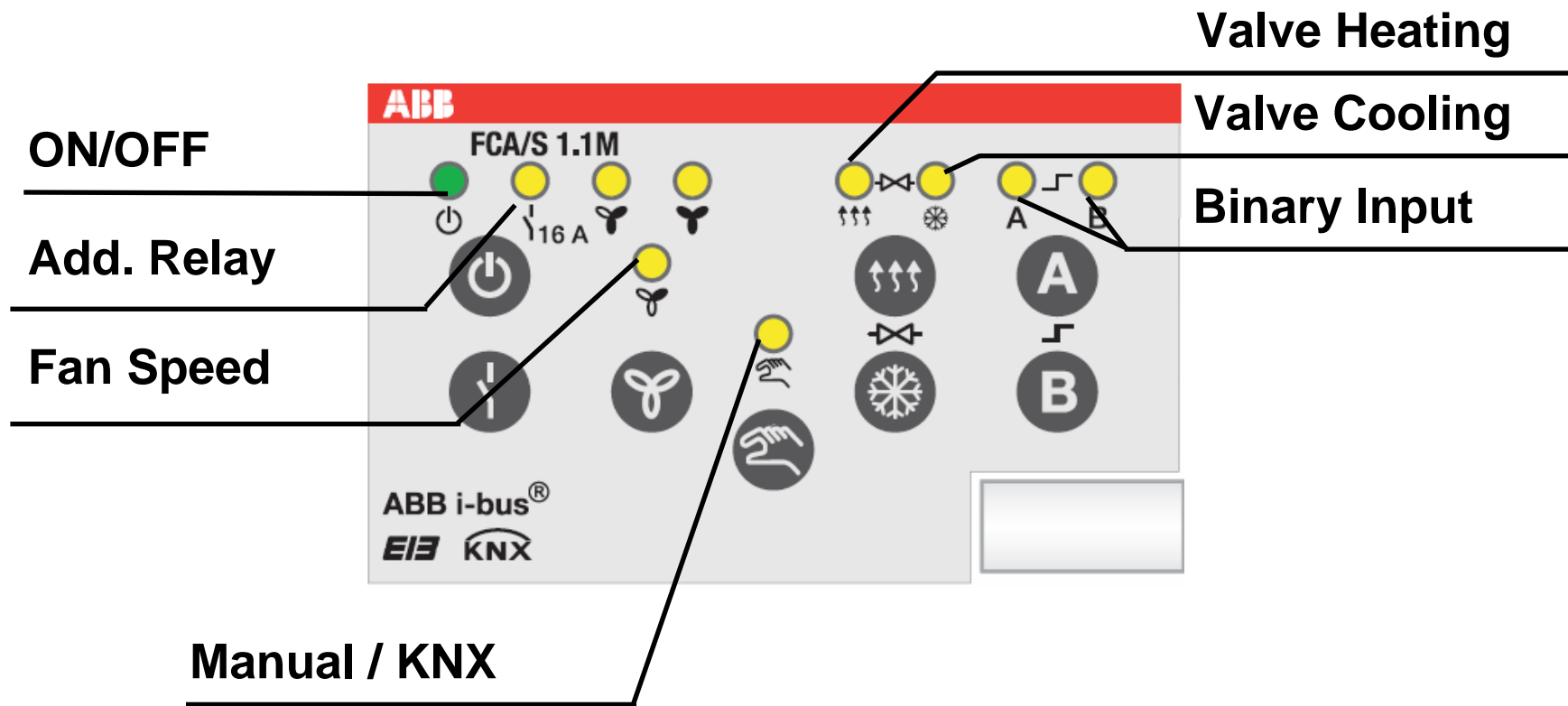

INFO:

Completely

Komplett

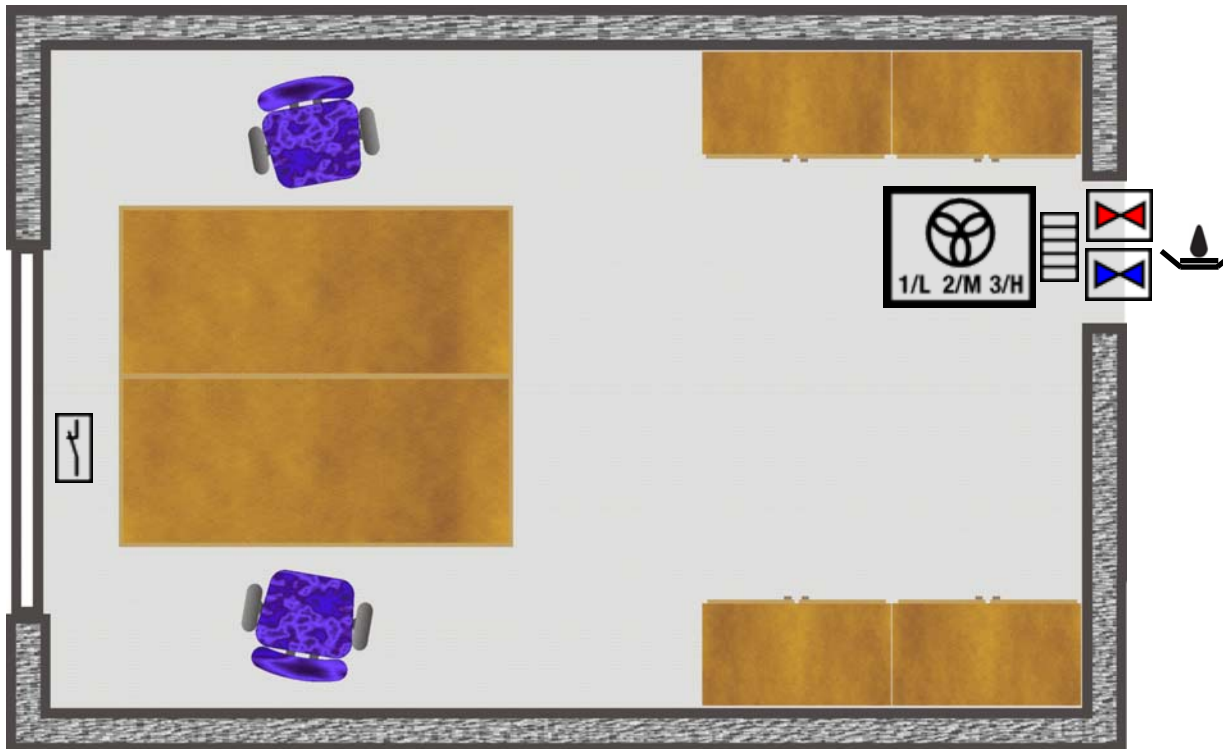



ABB i-bus[®] KNX

IP Interface IPS/S2.1
IP Router IPR/S2.1

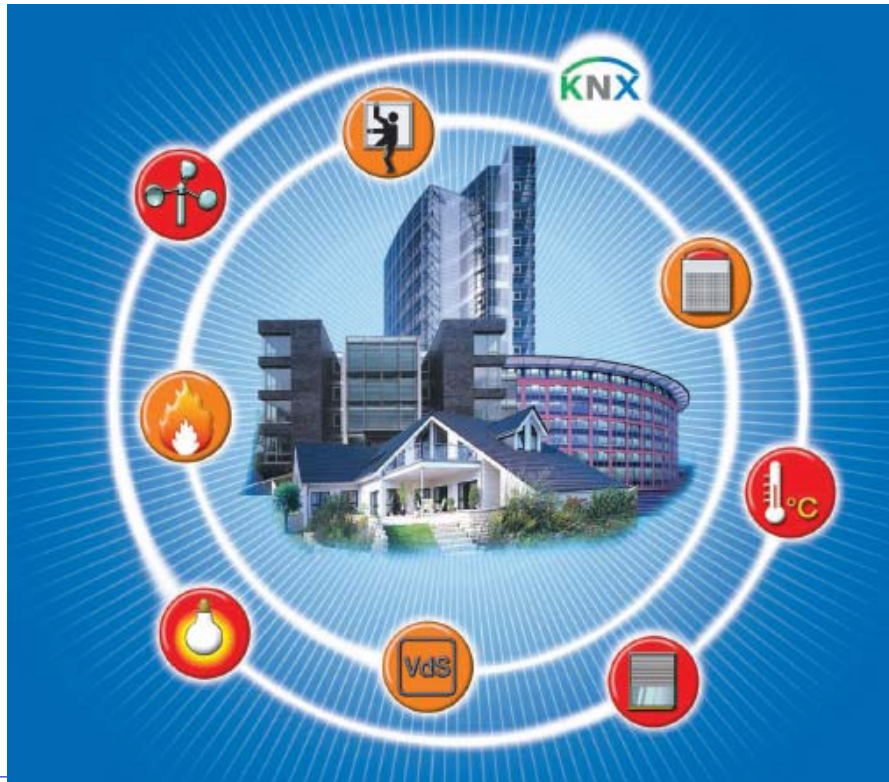

ABB

Overview



- Two devices
 - IP Interface IPS/S 2.1
 - IP Router IPR/S 2.1
- Common features
 - KNXnet/IP protocol
 - 2 Modules wide
 - Additional power supply (10..30V DC) necessary

IP Interface IPS/S2.1



- To connect a PC (for visualisation or programming) to KNX via IP
- KNXnet/IP capabilities:
 - Only Tunneling
- Main usage: Programming via IP
- Suitable to connect a PC with visualisation software in a small/medium-sized project with one line / area



IP Router IPR/S2.1



- To connect a PC (for visualisation or programming) to KNX via IP
- To connect lines / areas via IP
- KNXnet/IP capabilities:
 - Tunneling
 - Routing
- Main usage: Routing of KNX telegrams over IP in all kind of projects
- Additional feature: Programming via IP





ABB i-bus[®] KNX

Light Controller LR/S x.16.1 with LF/U 2.1



Light Controller LR/S x.16.1 with Sensor LF/U 2.1



- LR/S 2.16.1 and LR/S 4.16.1
- MDRC, *proM* Design
- 4 / 6 MW, ABB i-bus[®] KNX
- 2 / 4 independent outputs
- 16A – AC1, 10AX
- 1-10V Control Output max. 100mA
max. 100m Cable length
- 2 / 4 inputs for LF/U 2.1 max. 100m
shielded Cable
- Supplied via KNX
- Manual Operation and Indication of
Relay Position



Light Controller LR/S x.16.1 with Sensor LF/U 2.1

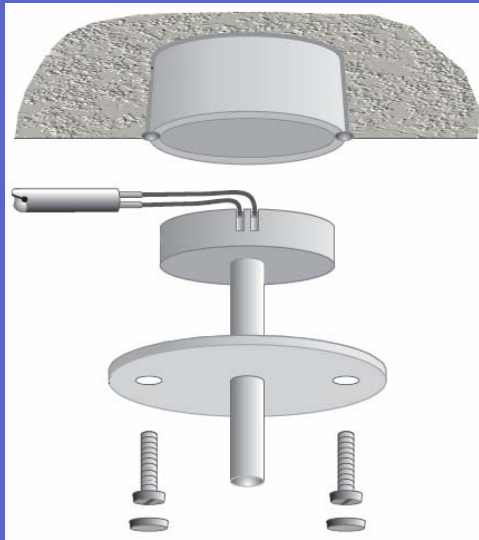

- Same design as LF/U 1.1
- Sensor adapted to Light Controller LR/S x.16.1
- Evaluated Brightness Detection with integrated Light Filter
- Brightness Detection optimised for 500 Lux
- Setpoint Adjustment via Calibration
- Electrically LF/U 1.1 and LF/U 2.1 are **not** compatible



- Basis are the Switch-/Dim Actuators SD/S x.16.1
- Parametrisation of channels individual or together
- Basic Functions
 - Switching
 - Dimming
 - Setting Values
- 4 Presets and 18 Scenes (8 Bit)
- Staircase Function
- Slave-Mode
- Forced Operation (2Bit and **1Bit**)
- Blocking of a channel

- Individual Dimming Speed for
 - Switching
 - Dimming (Setting via Bus is possible)
 - Setting Brightness
- Individual Dimming / Brightness Limit Values for
 - Switch, Dim and Staircase Lighting
 - Setting of Brightness, Preset, Scenes and Slave Mode
- Status Feedback via separate or Switching Object
- Characteristic Curve Adjustment



ABB i-bus[®] KNX

Room Solutions



Room Master

- Two Components
 - Room Master Basic RM/S 1.1
 - Room Master Premium RM/S 2.1
- MDRC, optimized for Control of 1-1,5 Rooms
- For Application in Hotel Rooms, Appartements, assisted Living Facilities and Hospitals
- The connection of Rooms via KNX (e.g. with the Reception in a Hotel) and central Functions offer an efficient Operation of Rooms



Outputs

Fan

Valves

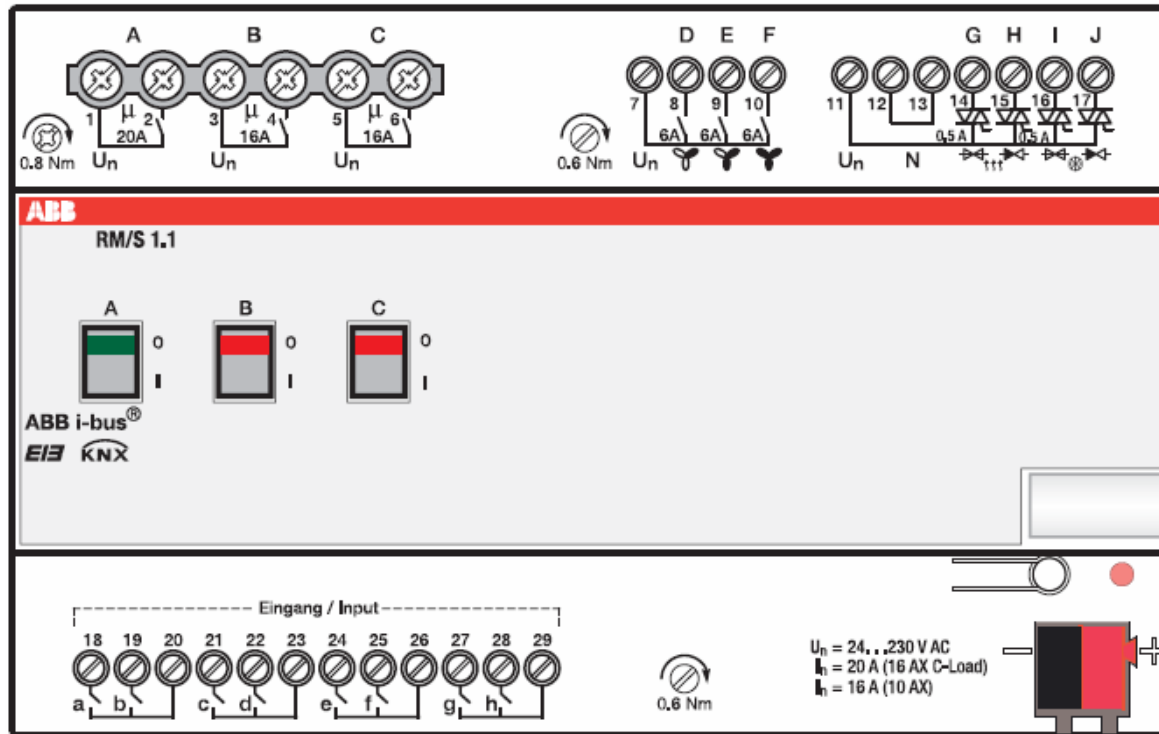

Inputs

	Number
Inputs	
Binary via Contact Scanning	8
Outputs	
Relay 20 A (16 AX)	1
Relay 16 A (10 AX)	2
Relay 6 A	3
Electronic Output 0,5 A	4

Outputs

Shutter/
Blinds

Fan

Valves

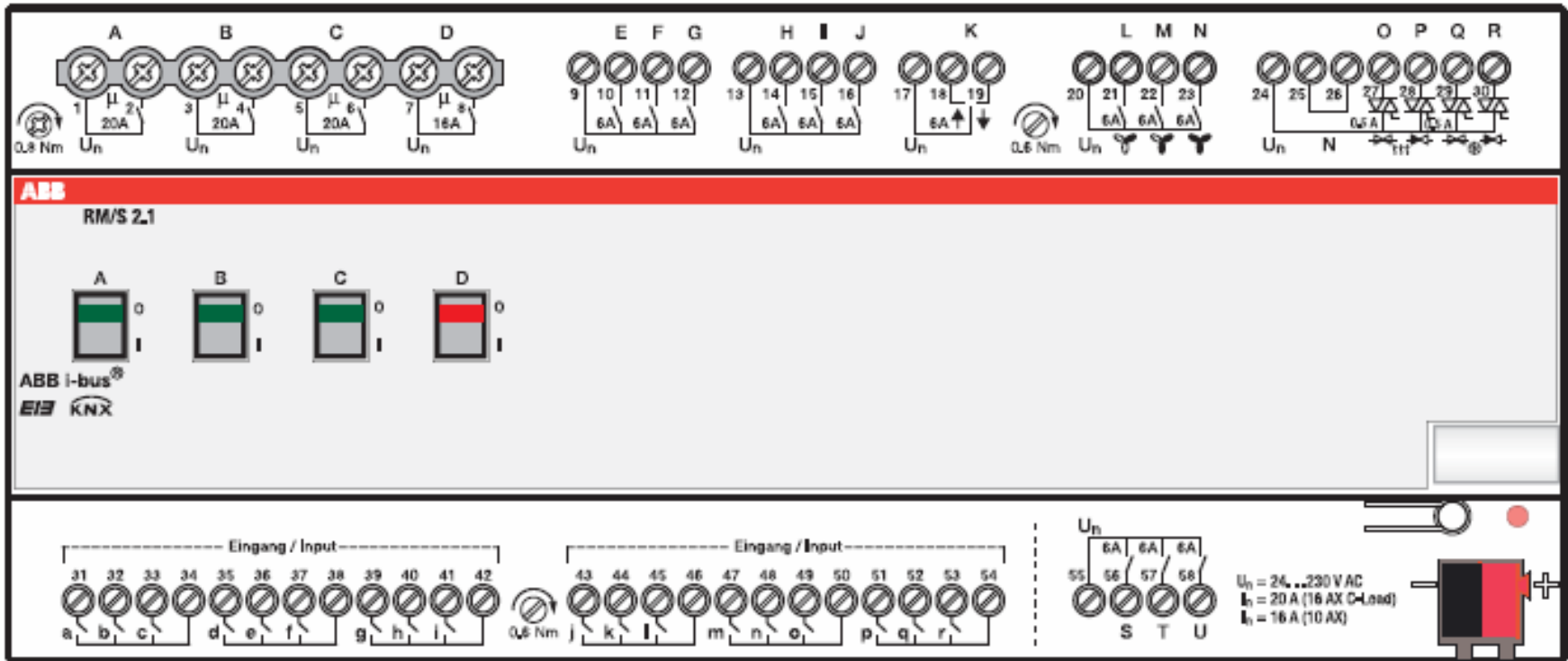

Inputs

Outputs



	Number
Inputs	
Binary via contact scanning	18
Outputs	
Relay 20 A (16 AX)	3
Relay 16 A (10 AX)	1
Relay 6 A	12
Electronic Output 0,5 A	4
Change Over Contact 6 A	1

INFO: Floor plan

Grundriss

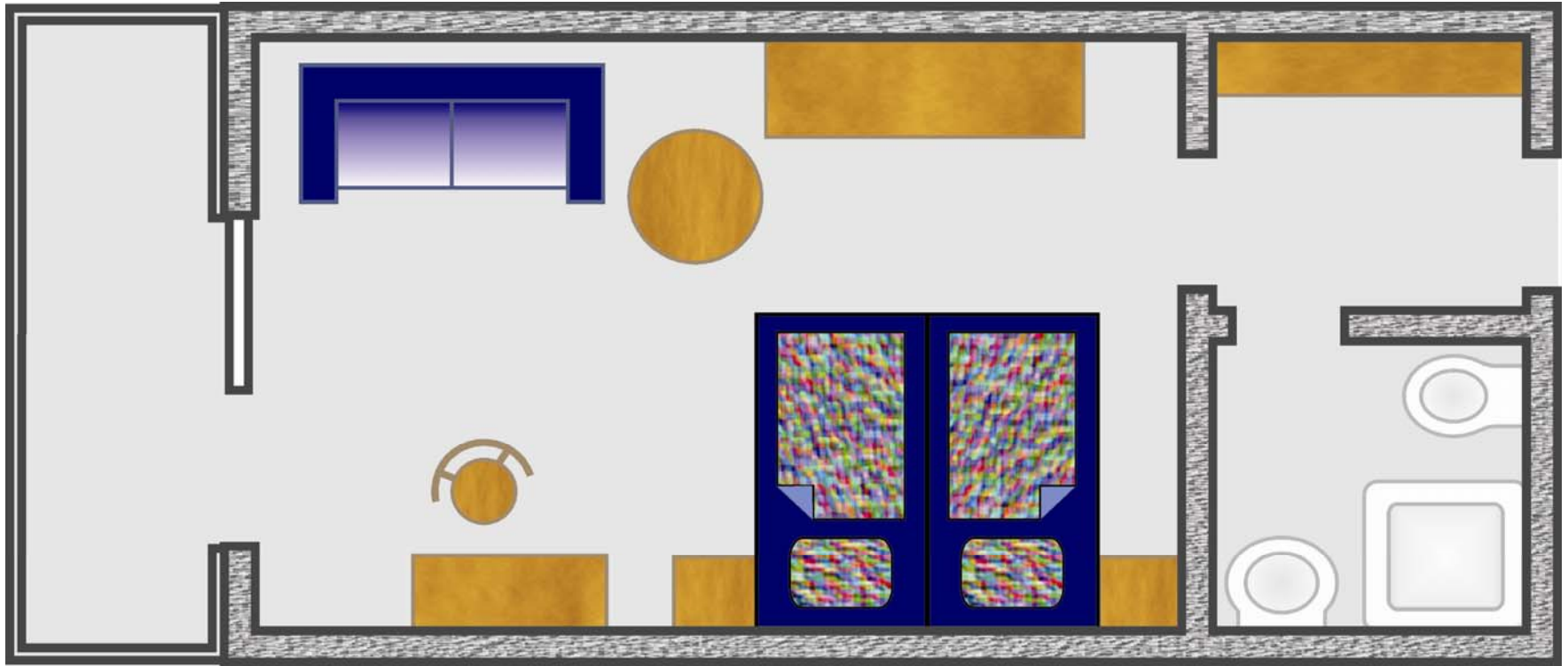

INFO: Completely

Komplett

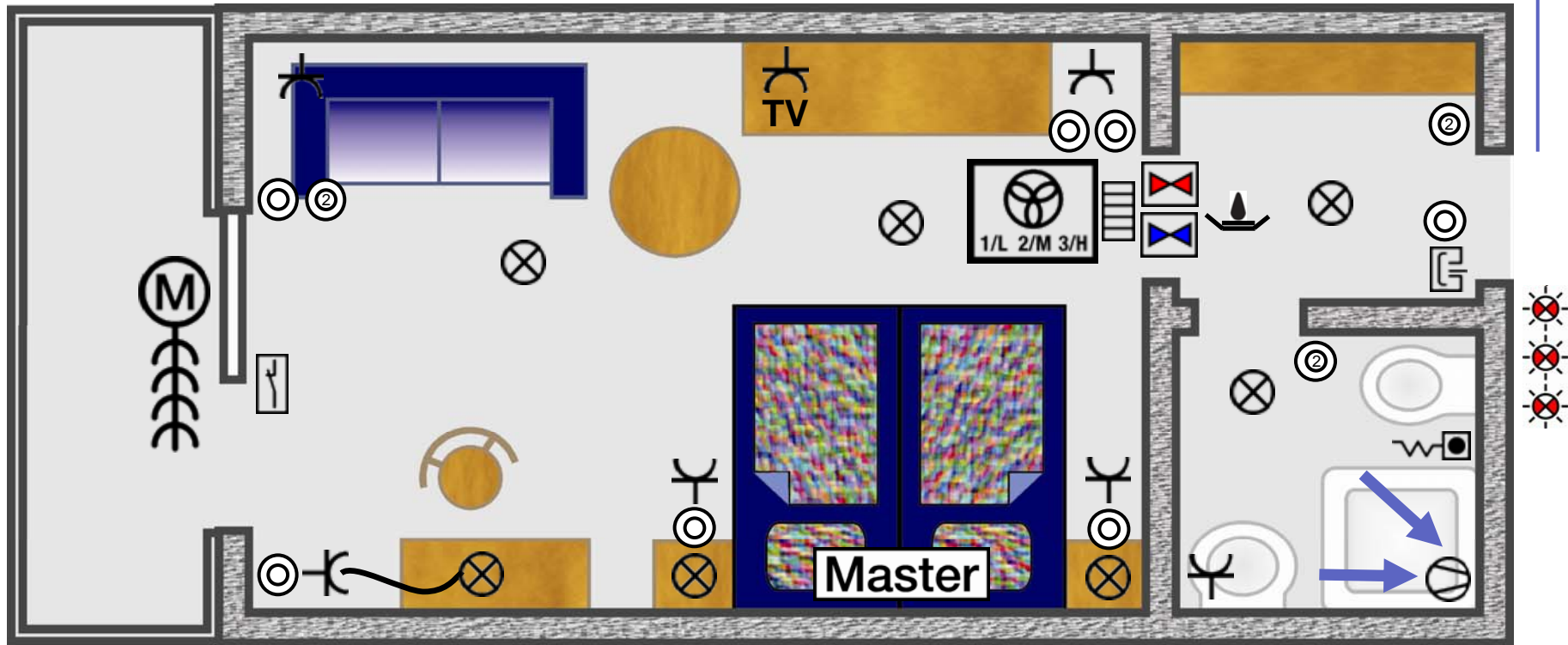

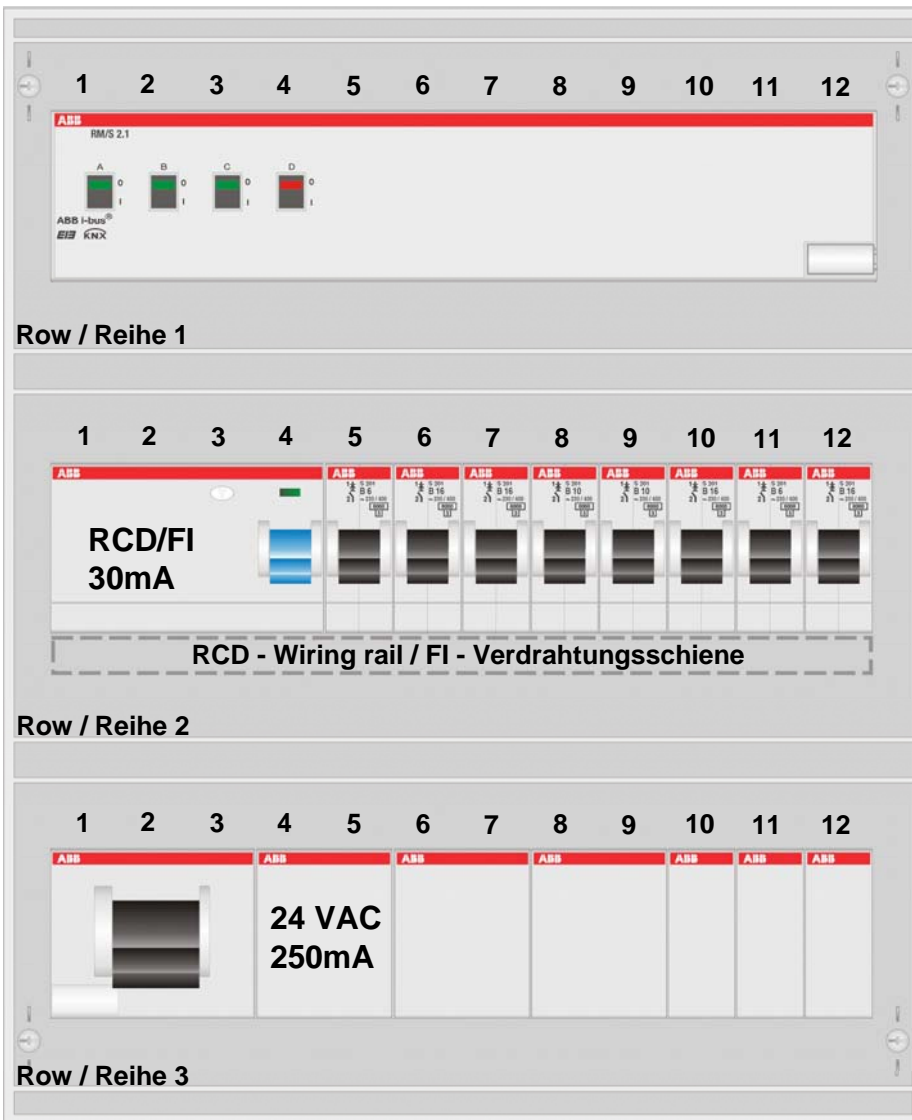

Row / Reihe 1:

1 - 12 Room Master / Raum Master

Row / Reihe 2:

1 - 4 RCD / FI

5 (6A) Main Supply (Bell Transformer) /
Spannungsversorgung (Klingelt.)

6 (16A) Socket Outlet Circuit / Steckdosenkreis

7 (16A) Socket Outlet Circuit / Steckdosenkreis

8 (10A) Electrical. Heater / Auxiliary Contact
Elektr. Heizung / Zusatzausgang

9 (10A) Lighting Circuit + Shutter /
Lichtstromkreis + Jalousie

10 (16A) Room supply / Raumversorgung

11 (6A) Fan Coil (HVAC / HKL)

12 (16A) Blower bathroom / Lüfter Badezimmer

Row / Reihe 3:

1 - 3 Main Switch 16A / Hauptschalter 16A

4 - 5 Bell Transform. / Klingel.(TS24/8-12-24)

6 - 12 Dimmer, Audio/Video, etc.



ABB i-bus® KNX



Universal Dim Actuator UD/S 2.300.2



Technics

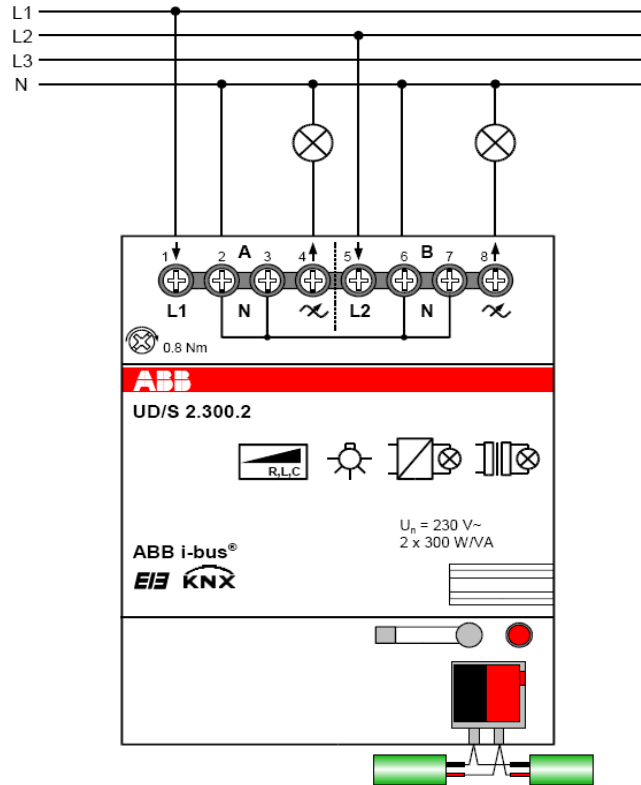

- Both channels can be operated on different phases (Neutral is looped through inside the device)
- Low power loss:
 - max. 4.5 W on maximum power
 - max. 500 mW when switched off
- Powerful application program
 - 18 light scenes
 - variable dimming speeds
 - ...
- Load detection can be disabled by defining a fix load type
- Improved stability against ripple control signals



ABB i-bus[®] KNX Phase Busbar PS 1/x/6-KNX



Phase Busbar - KNX

- Range ABB i-bus[®] KNX completed by two Phase Busbars
- Suitable for 6mm² Terminals
 - SA/S x.10.1, SA/S x.16.1, SA/S x.16.5(S)
 - SD/S x.16.1, LR/S x.16.1

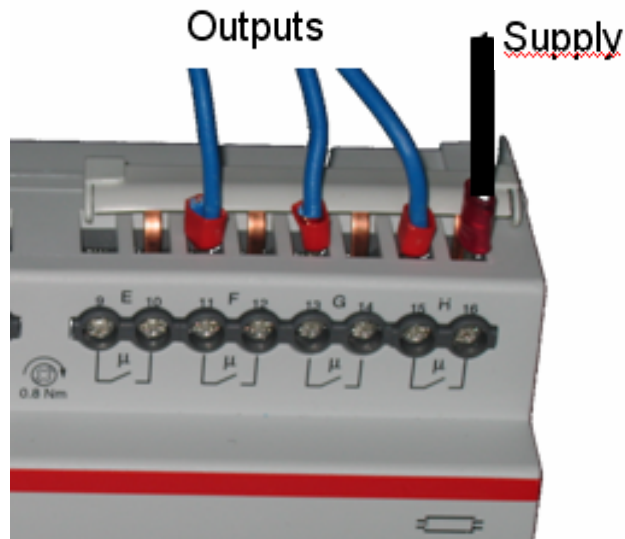

Phase Busbar - KNX

- PS 1/4/6-KNX und PS 1/60/6-KNX
- Phase Busbar with 4 Pins, Type PS 1/4/6-KNX

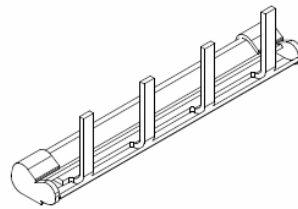

- Phase Busbar with 60 Pins, Type PS 1/60/6-KNX

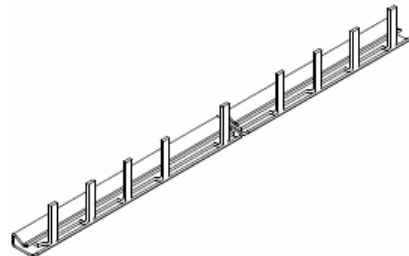

Phase Busbar - KNX

- End Cover PS-END 1-S

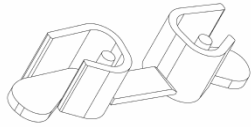

Phase Busbar - KNX

- Max. Current $I_S = 40A$

Einspeisung am
Schienenanfang

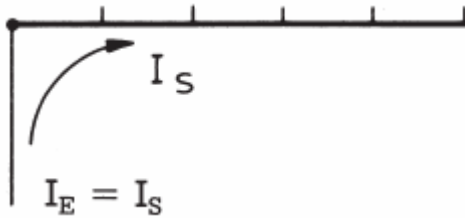

Einspeisung
im Verlauf
der Schiene oder
Mittleinspeisung

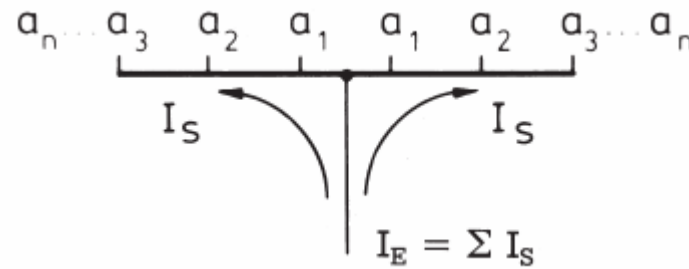



www.abb.com/knx